

OPIS PRODUKTU

- Możliwość dopasowania kąta między profilami
- Prosty montaż
- Dobra stabilizacja połączeń profili
- Możliwość budowania opraw o wielokątnych kształtach

Wypełnij puste pola

Nr produktu

Typ oprawy

Firma

Projekt

Data



SPECYFIKACJA TECHNICZNA

Przeznaczenie produktu

- do łączenia prostego i kąтового profili KLUŚ wyposażonych w „zamek mały” oraz do stabilizowania końców profili montowanych w ciągi

Montaż

- za pomocą wkrętów dociskowych

Dodatkowe informacje

- blacha nierdzewna, grubość 1,5 mm
- jeżeli kąt między łączonymi oprawami jest inny niż nominalny, możemy dogiać go do żądanej wartości o 5 stopni na stronę

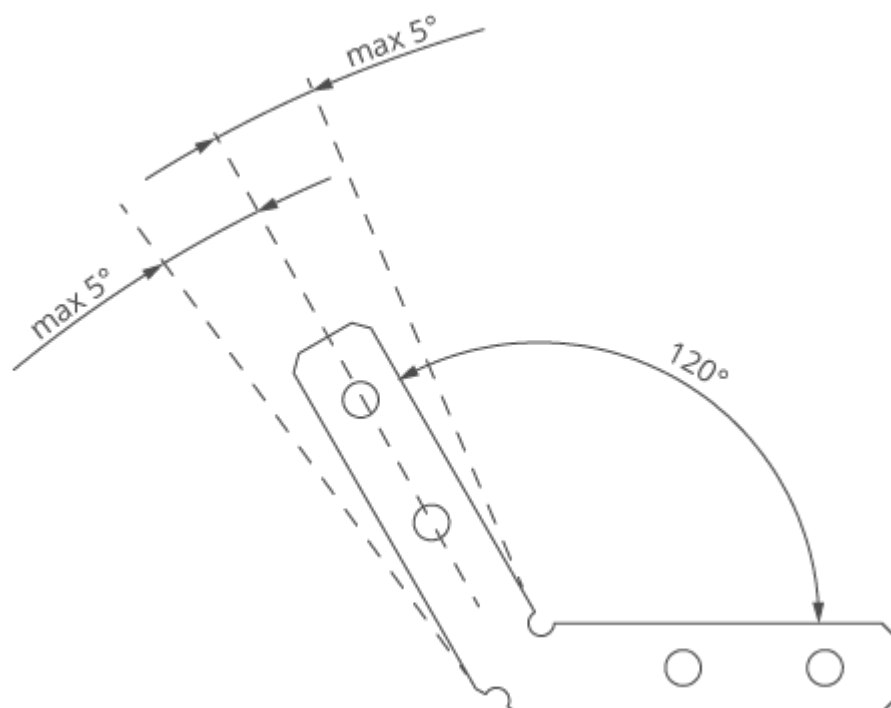

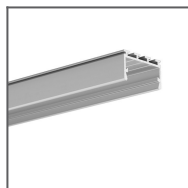
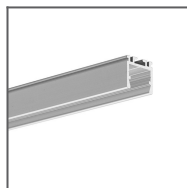
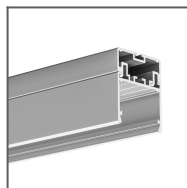
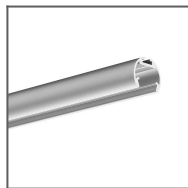
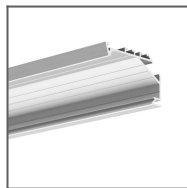
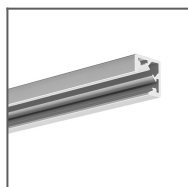
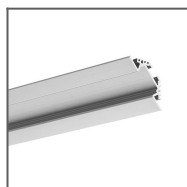
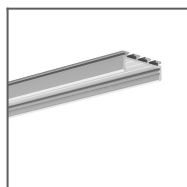
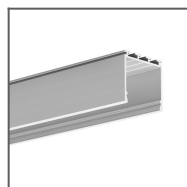
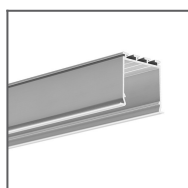
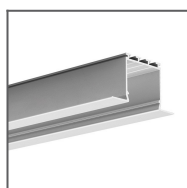
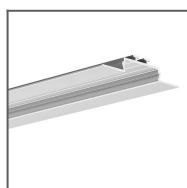
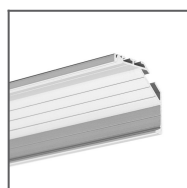
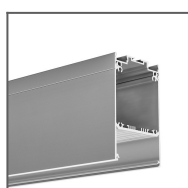
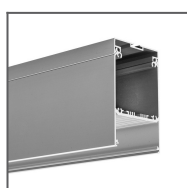
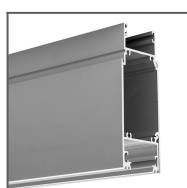
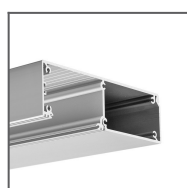
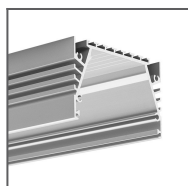
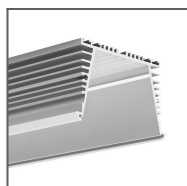
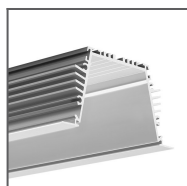
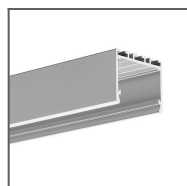
PROFILE POWIĄZANEProfil GIZA-LL
Ref: C0758Profil OPK-4
Ref: C0370Profil 3035
Ref: 18039Profil JAZ
Ref: B8547Profil OLEK
Ref: B8505Profil KOPRO-30
Ref: B7890Profil PDS-ZM
Ref: B7696Profil GLAD-45
Ref: B7009Profil KUBIK-45
Ref: B7697Profil PAC-ALU
Ref: B4370Profil GIZA
Ref: B5556Profil LIPOD
Ref: B5554Profil LOKOM
Ref: B5553Profil LARKO
Ref: B5552Profil OPAC-30
Ref: B6164Profil KOPRO
Ref: B6367Profil DES
Ref: 18030Profil GLADES
Ref: 18036Profil KIDES-DUO
Ref: 18032Profil KIDES
Ref: 18031Profil SEPOD
Ref: B6593Profil SEKOMA
Ref: B6595Profil SEKODU
Ref: B6597Profil 3035-O
Ref: B8441

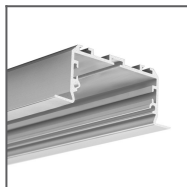

Profil LARKO-50
Ref: C0756

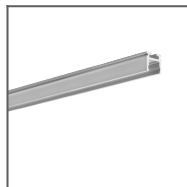

Profil PIKO-ZM
Ref: C1168

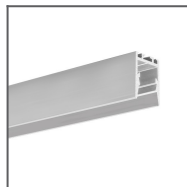

Profil PDS-ZMG
Ref: C1418

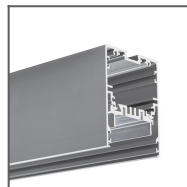

Profil MOD-50
Ref: 18047

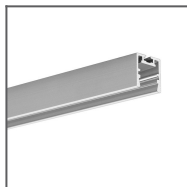

Profil PDS-ZM-PLUS
Ref: C2056

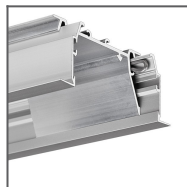

Profil RAM-KOL-50
Ref: 18060

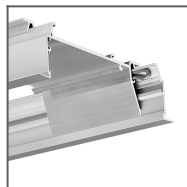

Profil RAM-KOL-100
Ref: 18062

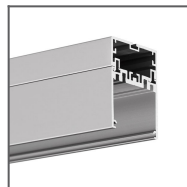

Profil 4050
Ref: 18050

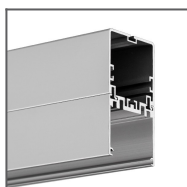

Profil 4050-W
Ref: 18051



Profil GIZA-DUO-LL
Ref: C2162

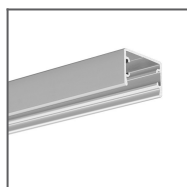

Profil GLAZA-LL
Ref: C2627