

OPIS PRODUKTU

Standardowa zawieszka do lekkich opraw oświetleniowych. Osadzana w profilu przez nawiercony wcześniej otwór. Zawieszka jest wyposażona w ZACZEP WZDŁUŻNY do PRĘTA FI-3

Wypełnij puste pola

Nr produktu

Typ oprawy

Firma

Projekt

Data

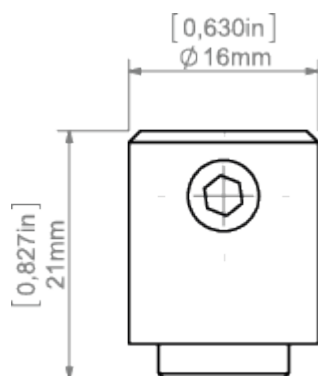
**SPECYFIKACJA TECHNICZNA****RYSUNEK TECHNICZNY**

PROFILE POWIĄZANE

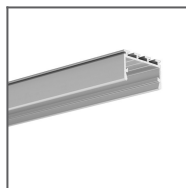

Profil GIZA-LL
Ref: C0758

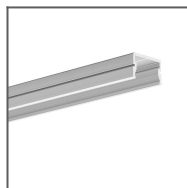

Profil SILER
Ref: B9325

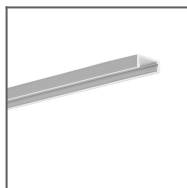

Profil MICRO-ALU
Ref: B1888

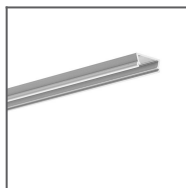

Profil TAMI
Ref: B5390

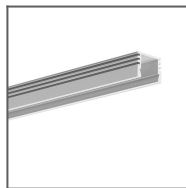

Profil PDS-4-ALU
Ref: B1718

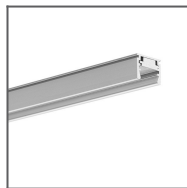

Profil REGULOR
Ref: B468+43

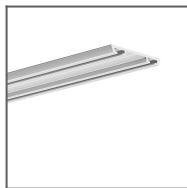

Profil TEST-36
Ref: B6639

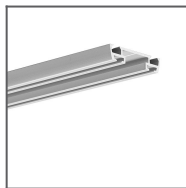

Profil TEST-74
Ref: W4507

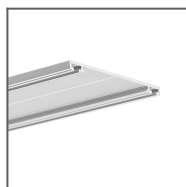

Profil TETRA-43
Ref: W4476

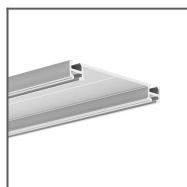

Profil TETRA-78
Ref: W4508

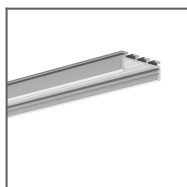

Profil GIZA
Ref: B5556

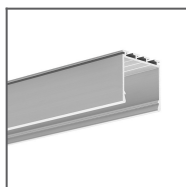

Profil LIPOD
Ref: B5554



Profil PDS-4-PLUS
Ref: C1263

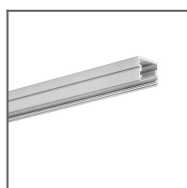

Profil TAPO
Ref: C1919

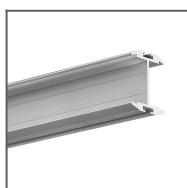

Profil GIZA-DUO-LL
Ref: C2162

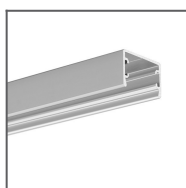

Profil GLAZA-LL
Ref: C2627

PRODUKTY POWIĄZANE

AKCESORIA

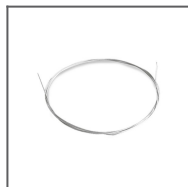

Linka stalowa FI-1
1m
Ref: 1397

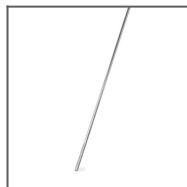

Pręt 100 PUSZ
mosiądz chrom 1
m
Ref: 42518

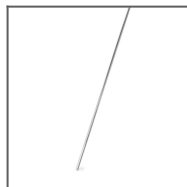

Pręt FI-3 mosiądz
chrom 1m
Ref: 42501

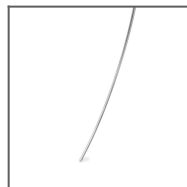

Pręt FI-3
nierdzewny 53cm
Ref: 1528