

OPIS PRODUKTU

Głowica służąca do zamocowania lekkich opraw oświetleniowych na wyciężnikach ściennych. Mocowana bezpośrednio do profilu

Wypełnij puste pola

Nr produktu

Typ oprawy

Firma

Projekt

Data

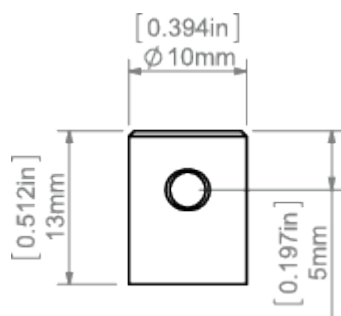
**SPECYFIKACJA TECHNICZNA****RYSUNEK TECHNICZNY**

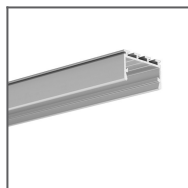
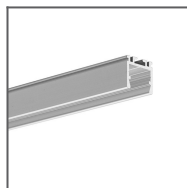
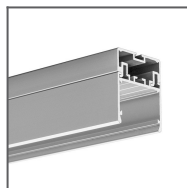
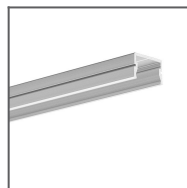
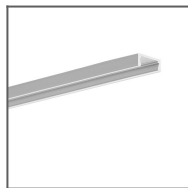
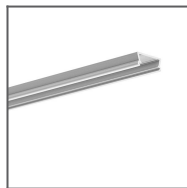
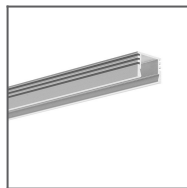
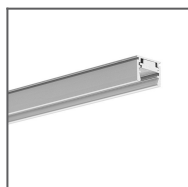
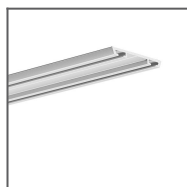
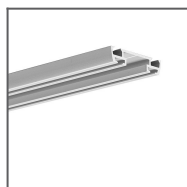
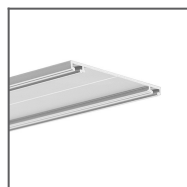
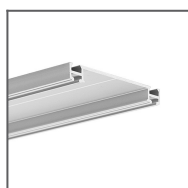
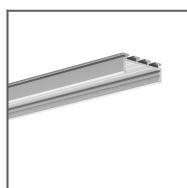
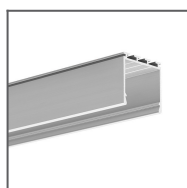
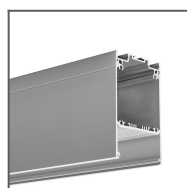
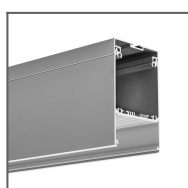
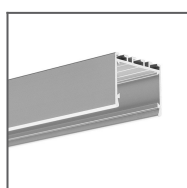
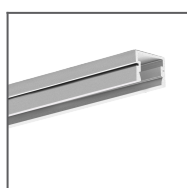
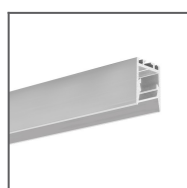
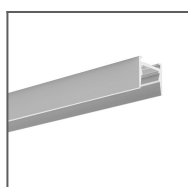
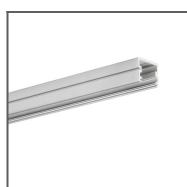
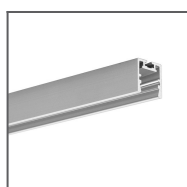
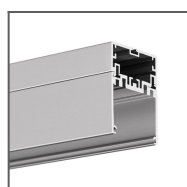
PROFILE POWIĄZANEProfil GIZA-LL
Ref: C0758Profil OPK-4
Ref: C0370Profil 3035
Ref: 18039Profil SILER
Ref: B9325Profil MICRO-ALU
Ref: B1888Profil TAMI
Ref: B5390Profil PDS-4-ALU
Ref: B1718Profil PDS-ZM
Ref: B7696Profil REGULOR
Ref: B468+43Profil TEST-36
Ref: B6639Profil TEST-74
Ref: W4507Profil TETRA-43
Ref: W4476Profil TETRA-78
Ref: W4508Profil GIZA
Ref: B5556Profil LIPOD
Ref: B5554Profil DES
Ref: 18030Profil GLADES
Ref: 18036Profil 3035-O
Ref: B8441Profil PDS-4-PLUS
Ref: C1263Profil PDS-ZMG
Ref: C1418Profil MICRO-HG
Ref: C1419Profil TAPO
Ref: C1919Profil PDS-ZM-PLUS
Ref: C2056Profil 4050
Ref: 18050

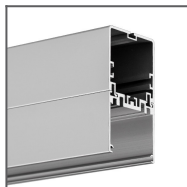

Profil 4050-W
Ref: 18051

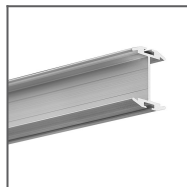

Profil GIZA-DUO-LL
Ref: C2162

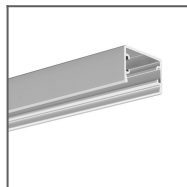

Profil GLAZA-LL
Ref: C2627

PRODUKTY POWIĄZANE

AKCESORIA

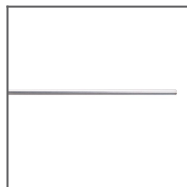
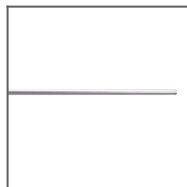
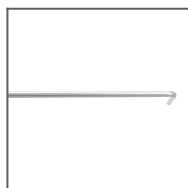
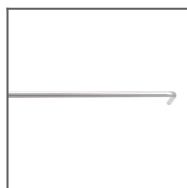
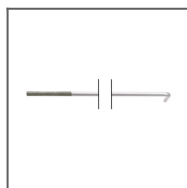
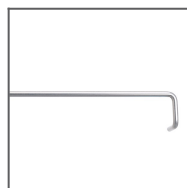
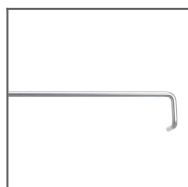
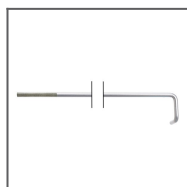
Pręt M5-K5 1m
Ref: 42209Wysięgnik K0-AB
Ref: 42101Wysięgnik K0-AB300
Ref: 42202Wysięgnik K0G-AB
Ref: 42102Wysięgnik K1-AB
Ref: 42113Wysięgnik K1-AB300
Ref: 42201Wysięgnik K1G-AB
Ref: 42115Wysięgnik K2-AB
Ref: 42114Wysięgnik K2-AB300
Ref: 42200Wysięgnik K2G-AB
Ref: 42116Wysięgnik K5G-AB
Ref: 42051