

OPIS PRODUKTU

Standardowa zawieszka zasilająca do lekkich opraw oświetleniowych. Zasilanie doprowadzane jest przez otwór wewnątrz zawieszki. Jedną zawieszka zasilany jest jeden biegun prądu. Wyposażona jest w ZACZEP WZDŁUŻNY do PRĘTA FI-3, który pełni rolę przewodu zasilającego

Wypełnij puste pola

Nr produktu

Typ oprawy

Firma

Projekt

Data



SPECYFIKACJA TECHNICZNA

RYSUNEK TECHNICZNY

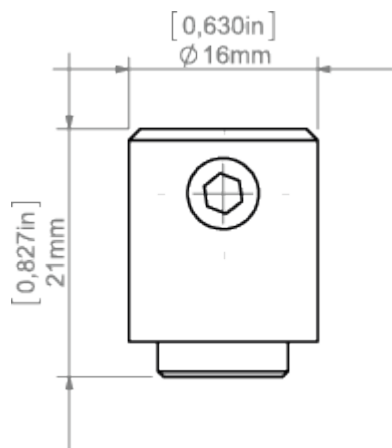

PROFILE POWIĄZANE

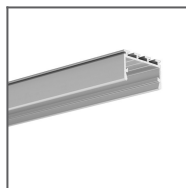

Profil GIZA-LL
Ref: C0758

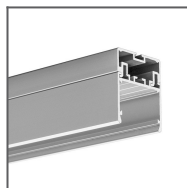

Profil 3035
Ref: 18039

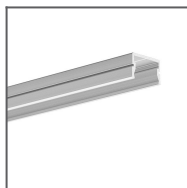

Profil SILER
Ref: B9325

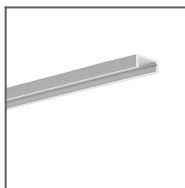

Profil MICRO-ALU
Ref: B1888

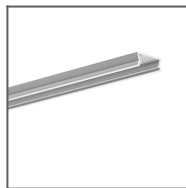

Profil TAMI
Ref: B5390

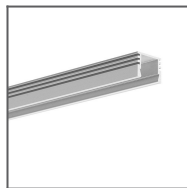

Profil PDS-4-ALU
Ref: B1718

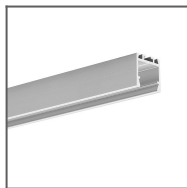

Profil PDS-ZM
Ref: B7696

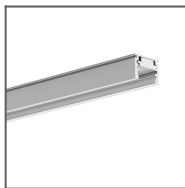

Profil REGULOR
Ref: B468+43

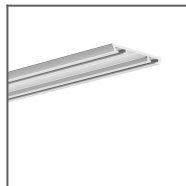

Profil TEST-36
Ref: B6639

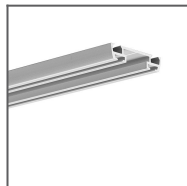

Profil TEST-74
Ref: W4507

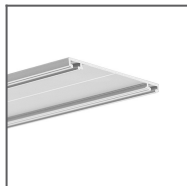

Profil TETRA-43
Ref: W4476

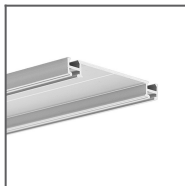

Profil TETRA-78
Ref: W4508

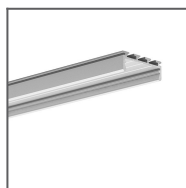

Profil GIZA
Ref: B5556

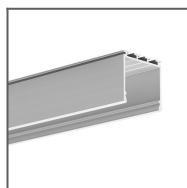

Profil LIPOD
Ref: B5554

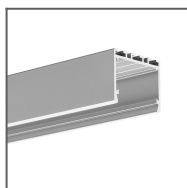

Profil 3035-O
Ref: B8441

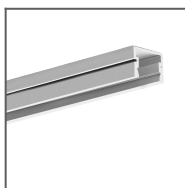

Profil PDS-4-PLUS
Ref: C1263

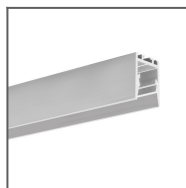

Profil PDS-ZMG
Ref: C1418

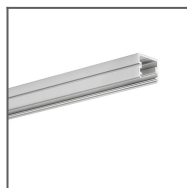

Profil TAPO
Ref: C1919

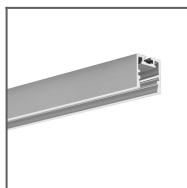

Profil PDS-ZM-PLUS
Ref: C2056

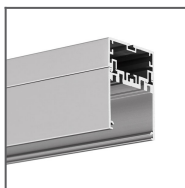

Profil 4050
Ref: 18050

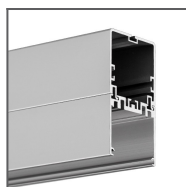

Profil 4050-W
Ref: 18051



Profil GIZA-DUO-LL
Ref: C2162

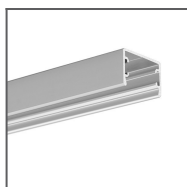

Profil GLAZA-LL
Ref: C2627

PRODUKTY POWIĄZANE

AKCESORIA

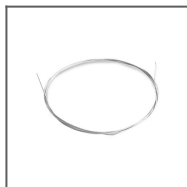

Linka stalowa FI-1
1m
Ref: 1397

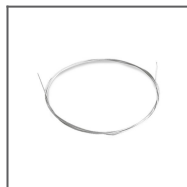

Linka stalowa z
rdzeniem CU FI
0,95 mm
Ref: 70240

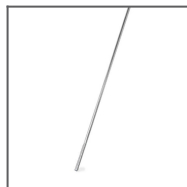

Pręt 100 PUSZ
mosiadz chrom 1
m
Ref: 42518

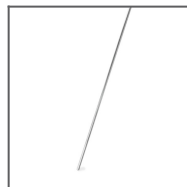

Pręt FI-3 mosiadz
chrom 1m
Ref: 42501

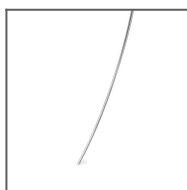

Pręt FI-3
nierdzewny 53cm
Ref: 1528