

## OPIS PRODUKTU

- Zaprojektowany do uzyskania stopnia ochrony IP64
- Możliwość uzyskania linii światła
- Możliwość wielu metod montażu
- Możliwość łączenia w proste i łamane ciągi

### WYKOŃCZENIE :

Srebrny anodowany Czarny anodowany RAL  

\*Inne kolory wykończenia dostępne na zamówienie

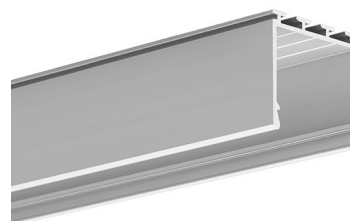

Wypełnij puste pola

Nr produktu

Typ oprawy

Firma

Projekt

Data

## SPECYFIKACJA TECHNICZNA

### Przeznaczenie produktu

- realizacje opraw oświetleniowych montowanych do powierzchni lub podwieszanych

### Montaż

- przy użyciu sprężyn powierzchniowych
- za pomocą akcesoriów do podwieszeń
- za pomocą klejów montażowych

### Dodatkowe informacje

- możliwość wykonania oprawy liniowej o stopniu ochrony IP64, co oznacza oprawę pyłoszczelną i bryzgodporną
- uzyskanie IP64 jest możliwe z osłonami: LIGER-22, MUN-22 i HS-22
- możliwość budowania opraw wielokątnych przy użyciu łączników ZM
- miejsce na pasek LED: 24.2 mm

Gięcie profilu

span{font-weight:600;}

Promień minimalny wewnętrzny	Promień minimalny zewnętrzny
3000 mm	3000 mm

- promień minimalny- promień gięcia, którego przekroczenie powoduje zniszczenie (odkształcenie, załamanie) profilu lub profil nie współpracuje z akcesoriami, osłonami, zaślepkami itp.

Więcej akcesoriów znajdziesz na naszej stronie [www.klusdesign.pl](http://www.klusdesign.pl)

- promień wewnętrzny- dotyczy profilu wygiętego tak, że osłonka znajduje się wewnątrz łuku
- promień zewnętrzny - dotyczy profilu wygiętego tak, że osłonka znajduje się z zewnątrz łuku
- krzywe nieregularne są możliwe do wykonania po konsultacji i indywidualnej wycenie
- przy wyginaniu profili anodowanych należy liczyć się z pękaniem powłoki anodowej (co w zależności od promienia może być bardziej lub mniej widoczne)

### Linia światła

- ✓ = Linia światła  
X = Widoczne punkty

Profil:	Model LED:	HS/HS-12/HS-22 mleczna	Liger/Liger-22 mleczna	Liger/Liger-22 czarna	G-K / G-L mleczna
LIPOD					
	1210	X	X	X	✓
	1220	✓	✓	✓	✓
	1275	✓	✓	✓	✓
	0530	✓	✓	✓	✓
	1910	✓	✓	✓	✓
	1820	✓	✓	✓	✓

### DOSTĘPNE DŁUGOŚCI

Nr Ref	wykończenie powierzchni	dostępne długości
B5554ANODA_1	Srebrny anodowany	1000 mm
B5554ANODA_2	Srebrny anodowany	2000 mm
B5554ANODA_3	Srebrny anodowany	3000 mm
B5554K7_1	Czarny anodowany	1000 mm
B5554K7_2	Czarny anodowany	2000 mm
B5554K7_3	Czarny anodowany	3000 mm
B5554L9005NS_1	Czarny RAL	1000 mm
B5554L9005NS_2	Czarny RAL	2000 mm
B5554L9005NS_3	Czarny RAL	3000 mm
B5554L9010NS_1	Biały RAL	1000 mm
B5554L9010NS_2	Biały RAL	2000 mm
B5554L9010NS_3	Biały RAL	3000 mm

### RYSUNEK TECHNICZNY

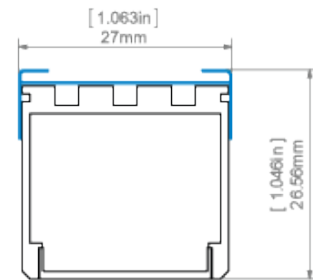
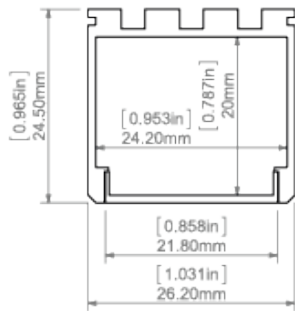

LIPOD profile and AM-24 mounting bracket  
profil LIPOD z mocownikiem AM-24

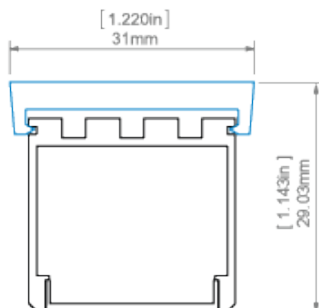

LIPOD profile and GIP mounting bracket  
profil LIPOD i mocownikiem GIP

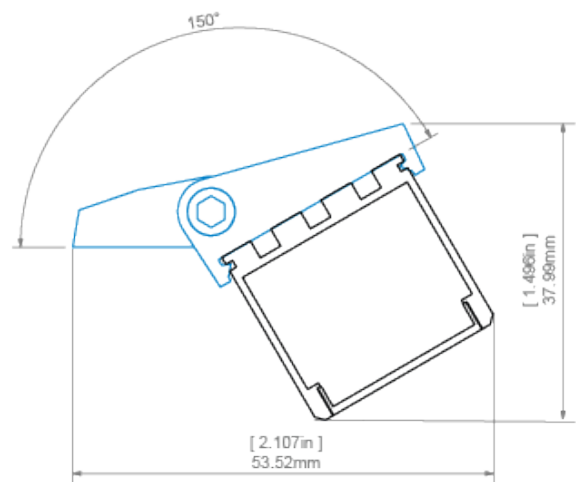

LIPOD profile and REGIP-UV mounting bracket  
profil LIPOD z mocownikiem REGIP-UV

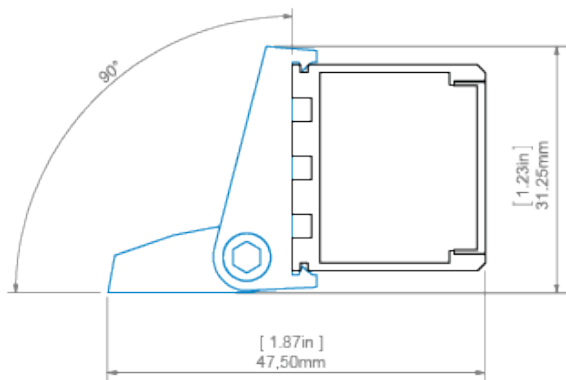

LIPOD profile and REGIP-UV mounting bracket  
profil LIPOD z mocownikiem REGIP-UV

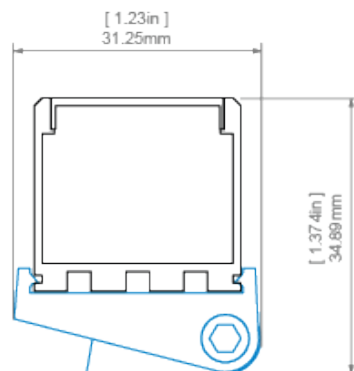

LIPOD profile and REGIP-UV mounting bracket  
profil LIPOD z mocownikiem REGIP-UV

**PROFILE POWIĄZANE**

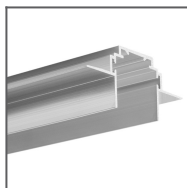

Profil TEKNIK-ZM  
Ref: C0399

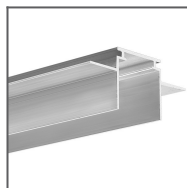

Profil TEKUS  
Ref: B6638V1

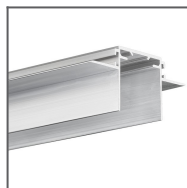

Profil TEKUS-ZM  
Ref: C1293

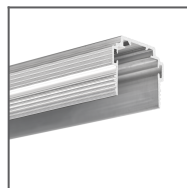

Profil TEKNIK-ZM-  
TK  
Ref: C1554

## PRODUKTY POWIĄZANE

### OSŁONY

#### OSŁONY CZARNE

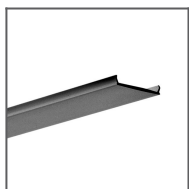

Osłona LIGER-22  
czarna  
Ref: 17087

80°



#### OSŁONY PRZEZROCZYSTE

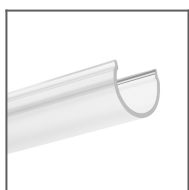

Osłona G-L  
przezroczysta  
Ref: 17006

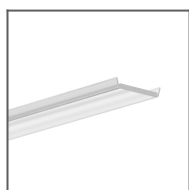

Osłona HS-22  
przezroczysta  
Ref: 17022

70°

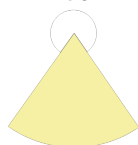

#### OSŁONY MLECZNE

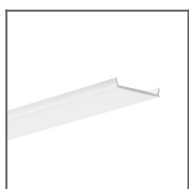

Osłona LIGER-22  
mleczna  
Ref: 17032V1

110°

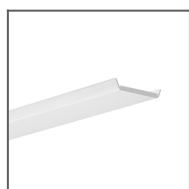
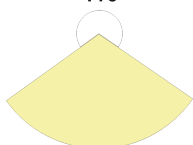

Osłona HS-22  
mleczna  
Ref: 17011

100°

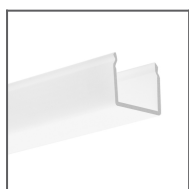

Osłona G-K  
mleczna  
Ref: 17007

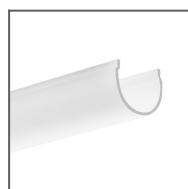

Osłona G-L  
mleczna  
Ref: 00413

## OSŁONY MROŻONE

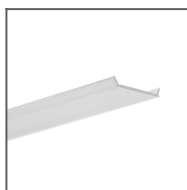

Osłona MUN-22  
mrożona  
Ref: 17042

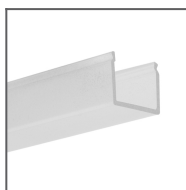

Osłona G-K  
mrożona  
Ref: 00415

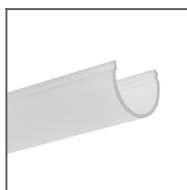

Osłona G-L  
mrożona  
Ref: 17008

60°



## ZASŁEPKI

### ZASŁEPKI PODSTAWOWE



Zaślepka LIPOD  
metalizowana  
Ref: 24051



Zaślepka LIPOD  
szara  
Ref: 24004



Zaślepka LIPOD  
czarna  
Ref: 24263

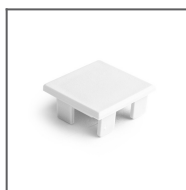

Zaślepka LIPOD  
biała  
Ref: 24283

## AKCESORIA

### ELEMENTY MOCOWAŃ



Mocownik REGIP-UV  
Ref: 24271



Mocownik GIP-UV  
czarny  
Ref: 24328

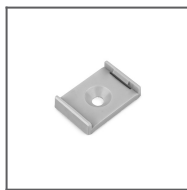

Mocownik GIP  
Ref: 24332

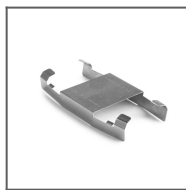

Mocownik AM-24  
Ref: 24235



Mocownik GIP-UV  
Ref: 24310

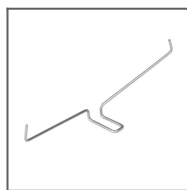

Sprężyna GP  
Ref: 00293



Głowica BZP-ZO  
Ref: 42214



Głowica BZP-ZZ  
Ref: 42215



Głowica BZP  
Ref: 42213



Zawieszka PUSZ-PRET-ZM czarna  
Ref: 42276L9005



Zawieszka PUSZ-LIN-ZM srebrna  
Ref: 42275



Zawieszka PUSZ-PRET-ZM srebrna  
Ref: 42276



Zawieszka srebrna FI-8-LIN-ZMZ  
Ref: 42286



Zawieszka PUSZ-LIN-ZM czarna  
Ref: 42275L9005



Zawieszka FI-10-ZM-P  
Ref: 42244



Zawieszka czarna FI-8-LIN-ZMZ  
Ref: 42286L9005



Zawieszka PUSZ-LIN-MR czarna  
Ref: 42278L9005



Zawieszka PUSZ-LIN-ZM  
Ref: 42256



Zawieszka FI-10-ZM-W  
Ref: 42242



Zawieszka PUSZ-PRET-ZM  
Ref: 42250



Zawieszka czarna FI-8-LIN-ZM  
Ref: 42285L9005



Zawieszka srebrna FI-8-LIN-ZM  
Ref: 42285



Zawieszka DP-ZZ  
Ref: 00651



Zawieszka DP-ZO  
Ref: 00649



Zawieszka DP  
Ref: 00644

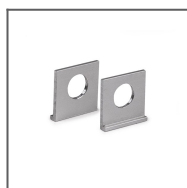

Zawieszka UCHO-ZM  
Ref: 42512

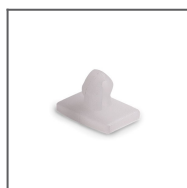

Zatraski TECHNIK  
Ref: 24003

## ELEMENTY ŁĄCZENIA PROFILI

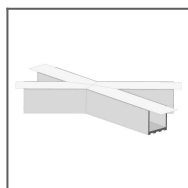

Kształtka X135  
Ref: \_

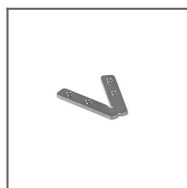

Łącznik ZM-45-G  
Ref: 42338

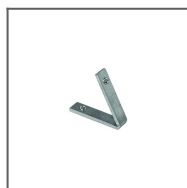

Łącznik ZM-PION-60  
Ref: 42316

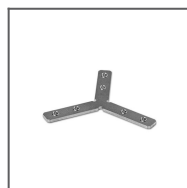

Łącznik ZM-Y120-G  
Ref: 42336

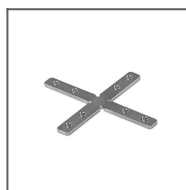

Łącznik ZM-X90-G  
Ref: 42334

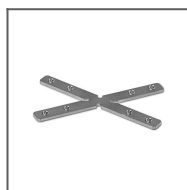

Łącznik ZM-X60-G  
Ref: 42332

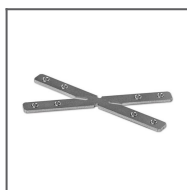

Łącznik ZM-X45-G  
Ref: 42330

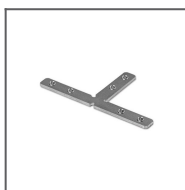

Łącznik ZM-T90-G  
Ref: 42328

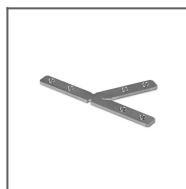

Łącznik ZM-T60-G  
Ref: 42326

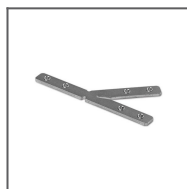

Łącznik ZM-T45-G  
Ref: 42324



Łącznik ZM-PION-120  
Ref: 42320



Łącznik ZM-PION-45  
Ref: 42314

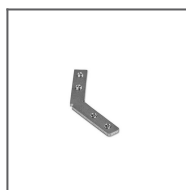

Łącznik ZM-L135-G  
Ref: 42310

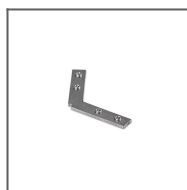

Łącznik ZM-L120-G  
Ref: 42308

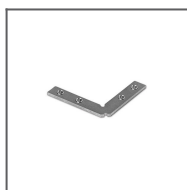

Łącznik ZM-L90-G  
Ref: 42306

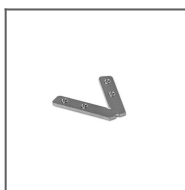

Łącznik ZM-L60-G  
Ref: 42304

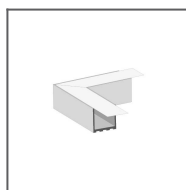

Kształtka L90  
Ref: \_

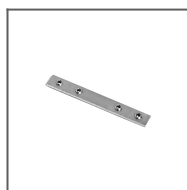

Łącznik ZM-180  
Ref: 42717

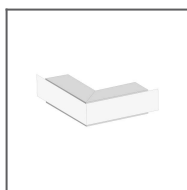

Kształtka L90PZ  
Ref: \_

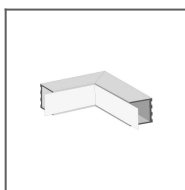

Kształtka L90PW  
Ref: \_

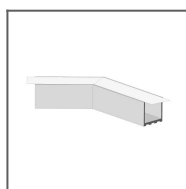

Kształtka L135  
Ref: \_

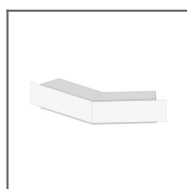

Kształtka L135PZ  
Ref: \_

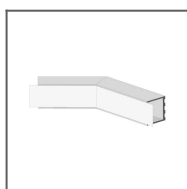

Kształtka L135PW  
Ref: \_

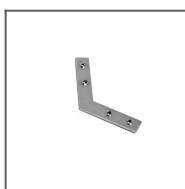

Łącznik ZM-120  
Ref: 42728

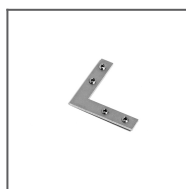

Łącznik ZM-90  
Ref: 42716

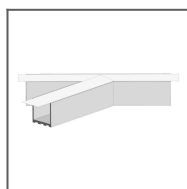

Kształtka T135L  
Ref: \_

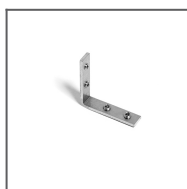

Łącznik ZM-PION-90  
Ref: 42718

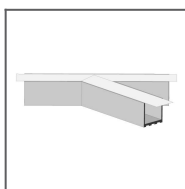

Kształtka T135R  
Ref: \_

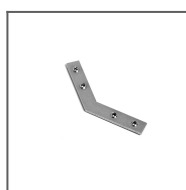

Łącznik ZM-135  
Ref: 42720

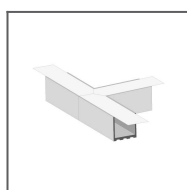

Kształtka T90  
Ref: \_

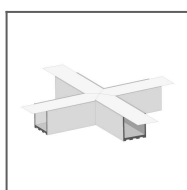

Kształtka X90  
Ref: \_

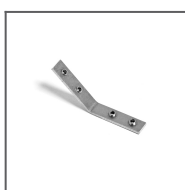

Łącznik ZM-PION-135  
Ref: 42719



Łącznik ZM-MINI-180  
Ref: 44501

## ZESTAWY MOCOWAŃ



Zestaw mocowań W1  
Ref: 42602



Zestaw mocowań W6  
Ref: 42604



Zestaw mocowań W7  
Ref: 42605



Zestaw mocowań M11  
Ref: 42609



Zestaw mocowań M12  
Ref: 42610

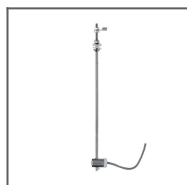

Zestaw mocowań M13  
Ref: 42611

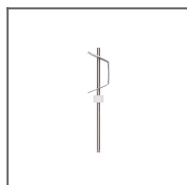

Mocowanie ZM-150  
Ref: 42118

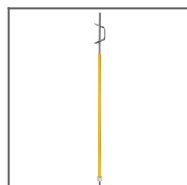

Mocowanie ZM-500  
Ref: 42119



Zestaw mocowań RD-1 czarny  
Ref: 42658L9005



Zestaw mocowań RG-1 czarny  
Ref: 42647L9005

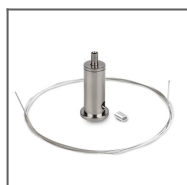

Zestaw mocowań RG-1 srebrny  
Ref: 42647NI



Zestaw mocowań RD-1 srebrny  
Ref: 42658NI



Zestaw mocowań RD-1 biały  
Ref: 42658L9010



Zestaw mocowań RD-1 srebrna satyna  
Ref: 42658GSS



Zestaw mocowań RD-2 srebrny  
Ref: 42653NI



Zestaw mocowań RD-3 srebrna satyna  
Ref: 42659GSS



Zestaw mocowań RD-4 srebrny  
Ref: 42657NI



Zestaw mocowań RD-2 biały  
Ref: 42653L9010



Zestaw mocowań RD-2 srebrna satyna  
Ref: 42653GSS



Zestaw mocowań RD-3 czarny  
Ref: 42659L9005

Zestaw mocowań  
RD-3 biały  
Ref: 42659L9010Zestaw mocowań  
RD-4 czarny  
Ref: 42657L9005Zestaw mocowań  
RG-1 srebrna  
satyna  
Ref: 42647GSS

## ELEMENTY USZCZELNIAJĄCE PROFILE

Dławnica 6,4x3  
Ref: 42264

## PODKŁADKI

Podkładki  
izolujące FI-3  
Ref: 42203Podkładki  
izolujące FI-5  
Ref: 42204Podkładki  
izolujące FI-6  
Ref: 42205

## INNE AKCESORIA

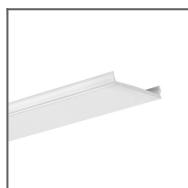
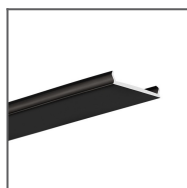
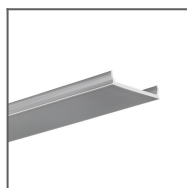
Maskownica  
MP-22 biała  
Ref: 17167L9010Maskownica  
MP-22 czarna  
Ref: 17167L9005Maskownica  
MP-22  
metalizowana  
Ref: 17167

## TAŚMY LED

### BIAŁE

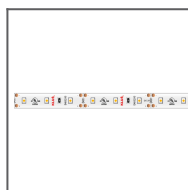

Taśma LED K-1210-12V  
Ref: K-1210-12V

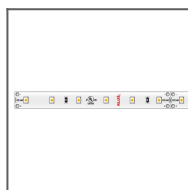

Taśma LED K-1210-24V  
Ref: K-1210-24V



Taśma LED K-1220-12V  
Ref: K-1220-12V

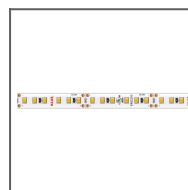

Taśma LED K-1220-24V  
Ref: K-1220-24V

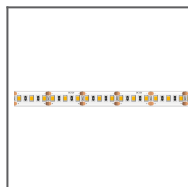

Taśma LED K-1275-12V  
Ref: K-1275-12V



Taśma LED K-1275-24V  
Ref: K-1275-24V

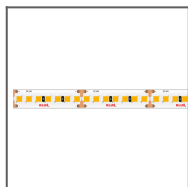

Taśma LED K-1820-HD-24V  
Ref: K-1820-HD-24V

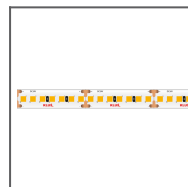

Taśma LED K-1910-HD-24V  
Ref: K-1910-HD-24V

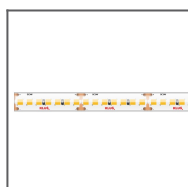

Taśma LED WP-K-1640-HD-IP65-24V  
Ref: WP-K-1640-HD-IP65-24V

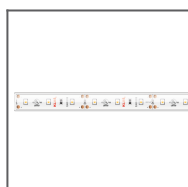

Taśma LED WP-K-1210-12V  
Ref: WP-K-1210-12V

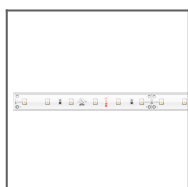

Taśma LED WP-K-1210-24V  
Ref: WP-K-1210-24V

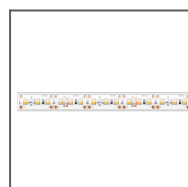

Taśma LED WP-K-1220-12V  
Ref: WP-K-1220-12V

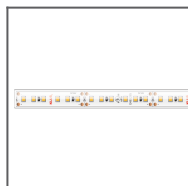

Taśma LED WP-K-1220-24V  
Ref: WP-K-1220-24V

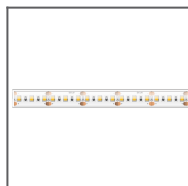

Taśma LED WP-K-1275-12V  
Ref: WP-K-1275-12V

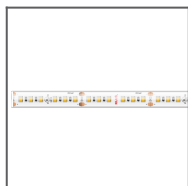

Taśma LED WP-K-1275-24V  
Ref: WP-K-1275-24V

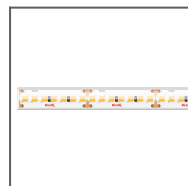

Taśma LED WP-K-1820-HD-24V  
Ref: WP-K-1820-HD-24V



Taśma LED WP-K-1910-HD-IP65-24V  
Ref: WP-K-1910-HD-IP65-24V



Taśma LED WP-K-1220-IP65-12V  
Ref: WP-K-1220-IP65-12V



Taśma LED WP-K-1220-IP65-24V  
Ref: WP-K-1220-IP65-24V

## WYSOKA SKUTECZNOŚĆ



Taśma LED K-HE-0480-HD-24V  
Ref: K-HE-0480-HD-24V

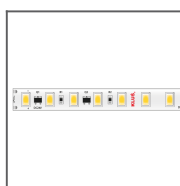

Taśma LED K-HE-0960-HD-24V  
Ref: K-HE-0960-HD-24V



Taśma LED K-HE-1440-HD-24V  
Ref: K-HE-1440-HD-24V



Taśma LED K-HE-1920-HD-24V  
Ref: K-HE-1920-HD-24V

LONG RUN

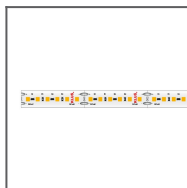

Taśma LED K-LR-1000-24V  
Ref: K-LR-1000-24V

RGB / RGB-W

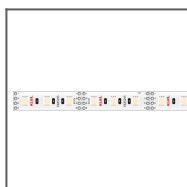

Taśma LED K-1275-  
RGB-12V  
Ref: K-1275-RGB-12V

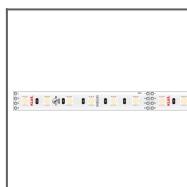

Taśma LED K-1275-  
RGB-24V  
Ref: K-1275-  
RGB-24V

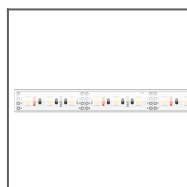

Taśma LED WP-K-1275-  
RGB-12V  
Ref: WP-K-1275-  
RGB-12V



Taśma LED WP-  
K-1275-RGB-24V  
Ref: WP-K-1275-  
RGB-24V

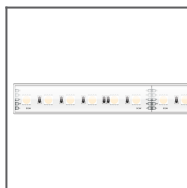

Taśma LED WP-K-1920-  
RGB+W-24V  
Ref: WP-K-1920-  
RGB+W-24V

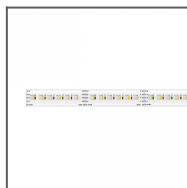

Taśma LED K-1530-  
RGB+W-24V  
Ref: K-1530-  
RGB+W-24V

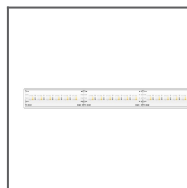

Taśma LED WP-K-1530-  
RGB+W-24V  
Ref: WP-K-1530-  
RGB+W-24V

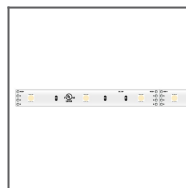

Taśma LED K-1215-  
RGB-12V  
Ref: K-1215-  
RGB-12V

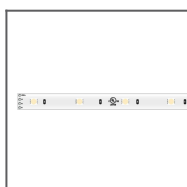

Taśma LED K-1215-  
RGB-24V  
Ref: K-1215-RGB-24V

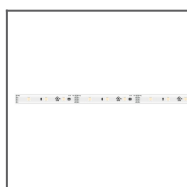

Taśma LED K-1225-  
RGB-12V  
Ref: K-1225-  
RGB-12V

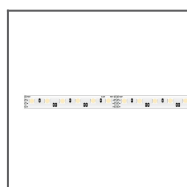

Taśma LED K-1225-  
RGB-24V  
Ref: K-1225-RGB-24V



Taśma LED WP-  
K-1215-RGB-12V  
Ref: WP-K-1215-  
RGB-12V



Taśma LED WP-K-1215-  
RGB-24V  
Ref: WP-K-1215-  
RGB-24V

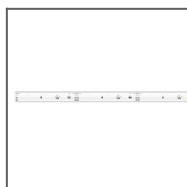

Taśma LED WP-  
K-1225-RGB-12V  
Ref: WP-K-1225-  
RGB-12V

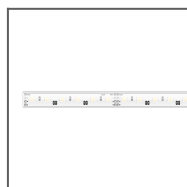

Taśma LED WP-K-1225-  
RGB-24V  
Ref: WP-K-1225-  
RGB-24V

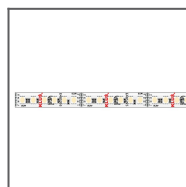

Taśma LED  
K-1920-120-RGB-24V  
Ref: K-1920-120-  
RGB-24V

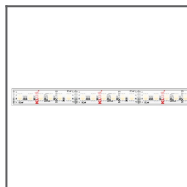

Taśma LED WP-  
K-1920-120-RGB-24V  
Ref: WP-K-1920-120-  
RGB-24V

#### REGULACJA TEMPERATURY BARWOWEJ / BARWY CIEPŁEJ

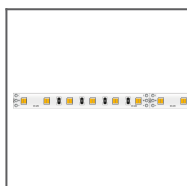

Taśma LED  
K-27/65-1920-24V  
Ref:  
K-27/65-1920-24V



Taśma LED WP-  
K-27/65-1920-24V  
Ref: WP-  
K-27/65-1920-24V

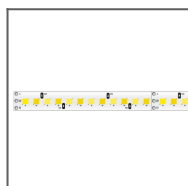

Taśma LED  
K-22/50-1728-24V  
Ref:  
K-22/50-1728-24V

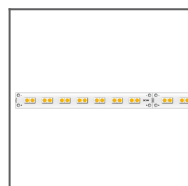

Taśma LED  
K-30/18-1770-24V  
Ref:  
K-30/18-1770-24V

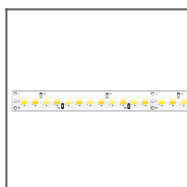

Taśma LED WP-  
K-22/50-1728-24V  
Ref: WP-  
K-22/50-1728-24V

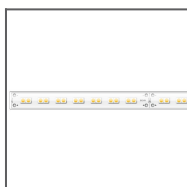

Taśma LED WP-  
K-30/18-1770-24V  
Ref: WP-  
K-3018-1770-24V

#### MATERIAŁY MARKETINGOWE



Plansza  
P230-90072M  
Ref: 90072M



Plansza  
P230-90154M  
Ref: 90154M



Plansza  
P230-90176M  
Ref: 90176M